



# The Numerical Simulation of Torque with Parameters of Speed and Angular Speed and High Acceleration in Five Freedoms of Robotic Arm

Xu R<sup>1,\*</sup>, Hur B<sup>1</sup> and Kim Y<sup>2</sup>

<sup>1</sup>Gyeongsang National University, Metallurgical & Materials Engineering Department, Korea

<sup>2</sup>Keimyung Univeristy, Materials Engineering Division, Korea

\*Corresponding author: Run Xu, Gyeongsang National University, Metallurgical Engineering Department, Gyeongsang nam-do, Chinju 52828, Korea; Email: [james\\_hur@163.com](mailto:james_hur@163.com)

## Abstract

There is big distance to attain 27.5KNm between the difference speeds of conditions  $v=0.5\sim 2.5\text{m/s}$  at angle speed  $\omega=65^\circ/\text{s}$  and acceleration  $\omega = 55^\circ/\text{s}^2$ . When the  $\omega$  increases the torque will become big, meantime when the speed  $v$  increases the torque is big too. The biggest one is 17KNm with above condition at angular speed  $\omega=40^\circ/\text{s}$  and acceleration  $\omega = 65^\circ/\text{s}^2$ . It means that the decreased acceleration will increase the torque. The least one is happened on  $\omega=35^\circ/\text{s}$ . there is little change between acceleration  $\omega = 55^\circ/\text{s}^2$  and  $65^\circ/\text{s}^2$ . There is a trend the former is a little larger than the later. Therefore the effective turn to torque is  $v>\omega>\omega$ .

**Keywords:** Numerical simulation; Torque; Angular speed; Acceleration; Five freedoms; Robotic arm

## Introduction

The robotic arm as a new mechanism has been wielded in factory for semi conduction etc. transportation and integration circuit welding. The auto and artificial intelligence robotic arm is developed from experimental lab to factory to launch producing. Therefore grasp the robotic arm kinematic and dynamic will become urgent and necessary in modern society. As a multiple system Lagrange equation may be solved its dynamics which is a method currently [1-3]. Due to its precision demand in process the position defining is very important especially to precise part making. Through defining a route it may be defined a displacement and then the velocity and acceleration may be defined through the equation besides the force and torque forces. For our checking strength and making size the dynamical forces may be used to it. Such as the motor size and arm shape and size will be checked out to design it. So in this study the dynamic forces may be calculated through Lagrange equation according to kinematic constant to check the feasibility on force to function [4-

6]. In this study the destination is that investigating the torque and speed & angular speed & angular acceleration. To separate three independence parts the velocity and acceleration will be calculated through displacement and force may be computed meantime with Lagrange equation separately. So each resolved resolution may be checked through comparing with others and literature. This is the destination in this paper to arouse the further research. In short, to increase the data base and look for the best conditions in motor choosing and robotic arm strength calculation efficiently the effect of robotic arm forces on angular speed and constant acceleration has been searched for a certain constant in this study. In this paper the three and five freedoms system is adopted to look for the differences between them to compute with numerical simulation.

## Numerical Simulation

In Figure 1 there are three freedoms in mechanical arm that name. Meantime there are two other ones call 4&5 which is included in

**Received date:** 07 February 2022; **Accepted date:** 10 February 2022; **Published date:** 15 February 2022

**Citation:** Run Xu, Hur B, Kim Y (2022). The Numerical Simulation of Torque with Parameters of Speed and Angular Speed and High Acceleration in Five Freedoms of Robotic Arm. SunText Rev Mat Sci 3(1): 122.

**DOI:** <https://doi.org/10.51737/2766-5100.2022.122>

**Copyright:** © 2022 Run Xu, et al. This is an open-access article distributed under the terms of the Creative Commons Attribution License, which permits unrestricted use, distribution, and reproduction in any medium, provided the original author and source are credited.

five freedoms as a rotational and crawling function. In Figure 1 the schematic shows the simplified principle of robot. The coordinate XAY is three freedoms and X'A'Y it five freedoms. In The system kinetic energy is [1-3]

$$E_k = \frac{1}{2} \sum_i^n (m_i v_i^2 + m_i v_i^2 + m_i v_i^2) \quad (1)$$

Here  $m_i$  : mass of i component ;  $J_{si}$  : rotary inertia of i component relative to center of mass;  $v_s$  : center of mass in i component;  $\omega_i$ : angular velocity in i component;  $v_1$ ,  $v_2$  and  $v_3$  is 1,2 and 3 velocities respectively.

$$v_D = \sqrt{\dot{X}_D^2 + \dot{Y}_D^2}$$

From Figure 2 it is known that position coordinate below

$$\begin{cases} X_D = \vec{l}_1 \sin \theta_1 + \vec{l}_2 \sin(\theta_1 + \theta_2) + \vec{l}_3 \sin(\theta_1 + \theta_2 + \theta_3) \\ Y_D = (\vec{l}_1 + \vec{l}_4) \cos \theta_1 + (\vec{l}_2 + \vec{l}_4) \cos(\theta_1 + \theta_2) + (\vec{l}_3 + \vec{l}_4) \cos(\theta_1 + \theta_2 + \theta_3) \end{cases} \quad (3)$$

Derivating the equation

We gain the  $\dot{X}_c$ ,  $\dot{Y}_c$ , and  $\dot{X}_3$  velocity in hand,  $\dot{\theta}_1$ ,  $\dot{\theta}_2$  and  $\dot{\theta}_3$  one in joints. Suppose that the acceleration is  $\ddot{\theta}_1$ ,  $\ddot{\theta}_2$  and  $\ddot{\theta}_3$  and the angular acceleration is  $\ddot{\omega}_1$ ,  $\ddot{\omega}_2$  and  $\ddot{\omega}_3$  in joints.

$$\begin{cases} \dot{X}_D = \dot{\theta}_1 \vec{l}_1 \cos \theta_1 + (\dot{\theta}_1 + \dot{\theta}_2) \vec{l}_2 \cos(\theta_1 + \theta_2) + (\dot{\theta}_1 + \dot{\theta}_2 + \dot{\theta}_3) \vec{l}_3 \cos(\theta_1 + \theta_2 + \theta_3) \\ \dot{Y}_D = \dot{\theta}_1 (\vec{l}_1 + \vec{l}_4) \sin \theta_1 + (\dot{\theta}_1 + \dot{\theta}_2) (\vec{l}_2 + \vec{l}_4) \sin(\theta_1 + \theta_2) + (\dot{\theta}_1 + \dot{\theta}_2 + \dot{\theta}_3) (\vec{l}_3 + \vec{l}_4) \sin(\theta_1 + \theta_2 + \theta_3) \end{cases} \quad (4)$$

$$v_D = \sqrt{\dot{X}_D^2 + \dot{Y}_D^2} = \sqrt{l_1^2 \dot{\theta}_1^2 + l_2^2 (\dot{\theta}_1 + \dot{\theta}_2)^2 + l_3^2 (\dot{\theta}_1 + \dot{\theta}_2 + \dot{\theta}_3)^2 + \dot{\theta}_1 l_4^2 \sin^2 \theta_1 + l_4^2 (\dot{\theta}_1 + \dot{\theta}_2)^2 \sin^2(\theta_1 + \theta_2) + l_4^2 (\dot{\theta}_1 + \dot{\theta}_2 + \dot{\theta}_3)^2 \sin^2(\theta_1 + \theta_2 + \theta_3) + 2l_1 l_3 \dot{\theta}_1 (\dot{\theta}_1 + \dot{\theta}_2 + \dot{\theta}_3) \cos(\theta_1 + \theta_3) + 2l_2 l_3 (\dot{\theta}_1 + \dot{\theta}_2) (\dot{\theta}_1 + \dot{\theta}_2 + \dot{\theta}_3) \cos \theta_3 + 2l_1 l_4 \dot{\theta}_1 \sin \theta_1 + 2l_2 l_4 (\dot{\theta}_1 + \dot{\theta}_2) \sin(\theta_1 + \theta_2) + 2l_3 l_4 (\dot{\theta}_1 + \dot{\theta}_2 + \dot{\theta}_3) \sin(\theta_1 + \theta_2 + \theta_3)} \quad (5)$$

C point velocity is

$$v_c = \sqrt{\dot{X}_c^2 + \dot{Y}_c^2} = \sqrt{l_1^2 \dot{\theta}_1^2 + l_2^2 (\dot{\theta}_1 + \dot{\theta}_2)^2 - 2l_1 l_2 \dot{\theta}_1 (\dot{\theta}_1 + \dot{\theta}_2) \cos \theta_2} \quad (6)$$

$$v_b = \vec{l}_1 \dot{\theta}_1 \quad (7)$$

Substituting two equations above to equation (1) has below

$$\begin{aligned} \frac{\partial E_k}{\partial \theta_1} &= \vec{l}_1 (\vec{l}_1 + \vec{l}_4 + \vec{l}_5) (m_1 + m_2 + m_3) \theta_1 + \vec{l}_2 (\vec{l}_3 + \vec{l}_4 + \vec{l}_5) m_2 (\theta_1 + \theta_2) + \vec{l}_3 (\vec{l}_3 + \vec{l}_4 + \vec{l}_5) m_3 (\theta_1 + \theta_2 + \theta_3) \\ &+ 2\vec{l}_4 m_3 \dot{\theta}_1 (\dot{\theta}_1 + \dot{\theta}_2)^2 \sin(\theta_1 + \theta_2) - 2\vec{l}_4 m_3 \dot{\theta}_1 (\dot{\theta}_1 + \dot{\theta}_2 + \dot{\theta}_3)^2 \sin(\theta_1 + \theta_2 + \theta_3) - \vec{l}_1 \vec{l}_2 m_2 \dot{\theta}_1 (\dot{\theta}_1 + \dot{\theta}_2 + \dot{\theta}_3) \sin(\theta_1 + \theta_2) \\ &+ (\vec{l}_4 + \vec{l}_5) (m_2 + m_2 + m_3) \theta_1 + (\vec{l}_4 + \vec{l}_5) m_2 (\theta_1 + \theta_2) + 2\vec{l}_1 \vec{l}_4 m_3 (\dot{\theta}_1 + \dot{\theta}_2) \cos(\theta_1 + \theta_2) + 2\vec{l}_1 \vec{l}_4 m_3 (\dot{\theta}_1 + \dot{\theta}_2 + \dot{\theta}_3) \cos(\theta_1 + \theta_2) \end{aligned} \quad (8)$$

this study the five freedoms not three one is deduced since it is complicated (Figure 1,2).

$$\begin{aligned} \frac{\partial E_k}{\partial \theta_2} = & \vec{l}_2 (\vec{l}_2 + \vec{l}_4 + \vec{l}_5) m_2 (\theta_1 + \theta_2) + \vec{l}_3 (\vec{l}_3 + \vec{l}_4 + \vec{l}_5) m_3 (\theta_1 + \theta_2 + \theta_3) + 4 \vec{l}_4 m_3 \dot{\theta}_1 \sin \theta_2 + 2 \vec{l}_4 m_3 \dot{\theta}_1 (\dot{\theta}_1 + \dot{\theta}_2)^2 \sin \\ & (\theta_1 + \theta_2) + 2 \vec{l}_4 m_3 \dot{\theta}_1 (\dot{\theta}_1 + \dot{\theta}_2 + \dot{\theta}_3)^2 \sin(\theta_1 + \theta_2 + \theta_3) - 2 \vec{l}_1 \vec{l}_2 m_3 \dot{\theta}_1 (\dot{\theta}_1 + \dot{\theta}_2) \sin \theta_2 - 2 \vec{l}_1 \vec{l}_2 m_3 \dot{\theta}_1 (\dot{\theta}_1 + \dot{\theta}_2) \sin \theta_2 - (\vec{l}_4 \\ & + \vec{l}_5) m_3 \dot{\theta}_1 (\theta_1 + \theta_2) + 2 \vec{l}_1 \vec{l}_4 m_3 \dot{\theta}_1 (\dot{\theta}_1 + \dot{\theta}_2 + \dot{\theta}_3) \cos(\theta_1 + \theta_2) - (\vec{l}_4 + \vec{l}_5) m_3 \dot{\theta}_1 (\theta_1 + \theta_2) + 2 \vec{l}_1 \vec{l}_4 m_3 \dot{\theta}_1 \cos(\theta_1 + \theta_2) + \\ & 2 \vec{l}_3 \vec{l}_4 m_3 (\dot{\theta}_1 + \dot{\theta}_2 + \dot{\theta}_3) \cos(\theta_1 + \theta_2 + \theta_3) \end{aligned} \quad (9)$$

$$\begin{aligned} \frac{\partial E_k}{\partial \theta_3} = & \vec{l}_3 (\vec{l}_3 + \vec{l}_4 + \vec{l}_5) (\theta_1 + \theta_2 + \theta_3) - 2 \vec{l}_4 m_3 (\dot{\theta}_1 + \dot{\theta}_2 + \dot{\theta}_3)^2 \sin(\theta_1 + \theta_2 + \theta_3) - \vec{l}_2 \vec{l}_3 m_3 (\dot{\theta}_1 + \dot{\theta}_2) \\ & (\dot{\theta}_1 + \dot{\theta}_2 + \dot{\theta}_3) \sin \theta_3 - 2 \vec{l}_3 \vec{l}_4 m_3 (\dot{\theta}_1 + \dot{\theta}_2 + \dot{\theta}_3) \cos(\theta_1 + \theta_2 + \theta_3) \end{aligned} \quad (10)$$

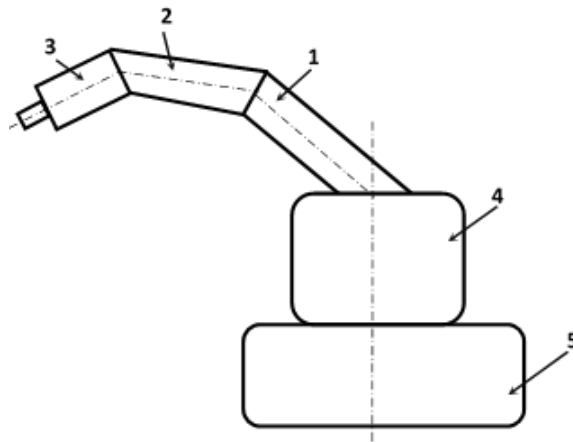

Figure 1: Construction schematic of mechanical arm in series in robot 3-hand part; 2-wrist part; 1-arm part; 4-waist part; 5-two crawling wheel.

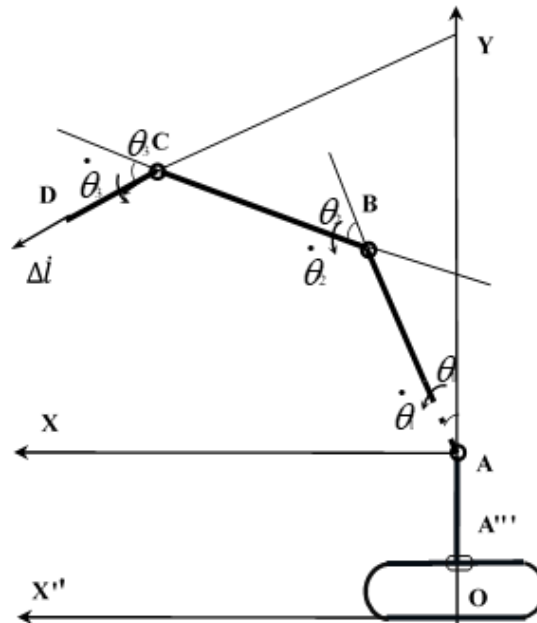
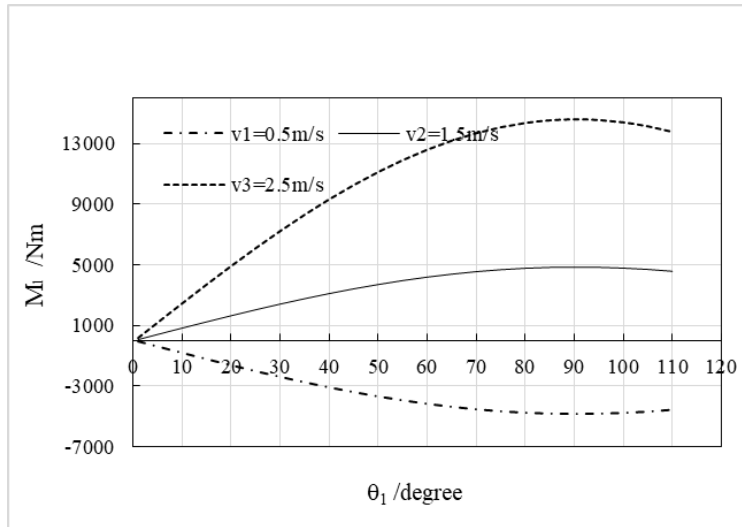
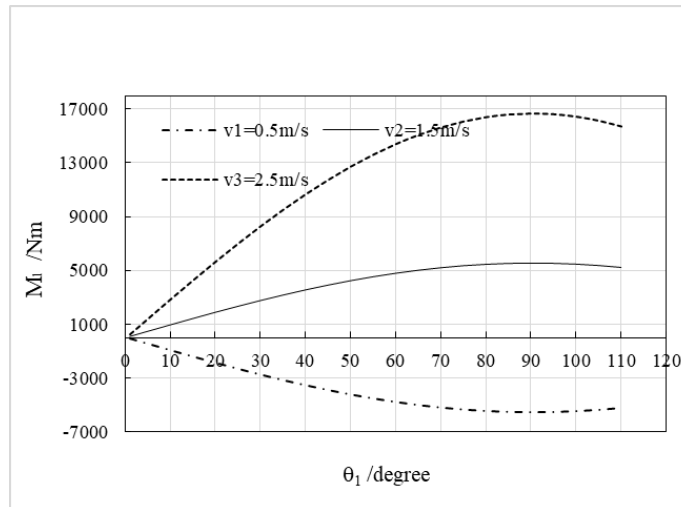

Figure 2: Principle schematic of mechanical arm in series in robot.



(a)  $\omega = 35\%/s$ .



(b)  $\omega = 40\%/s$ .

Figure 3: The torque with time and speed  $v$  under angular speed  $\omega$  and acceleration  $\omega'$  of  $65\%/s^2$ .

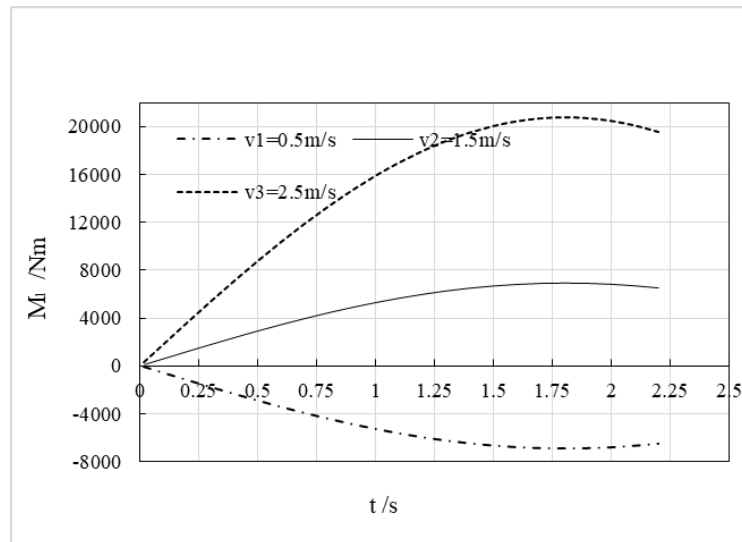

(a)  $\omega = 50\%/s$ .

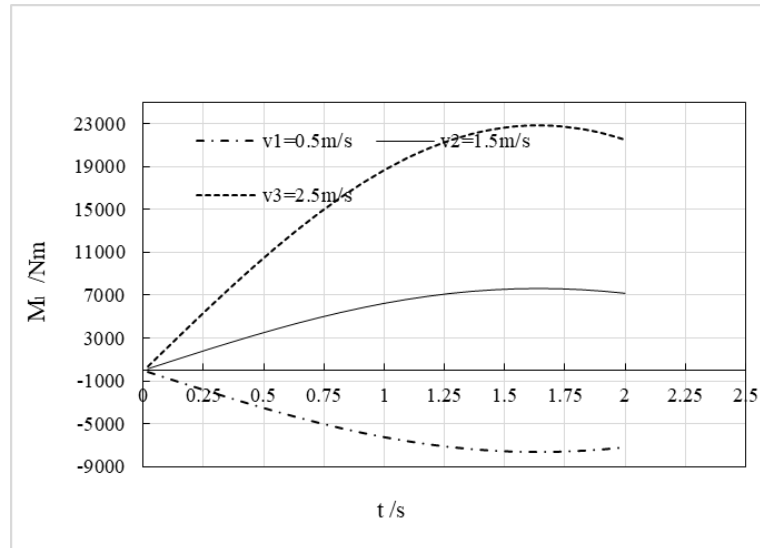

(b)  $\omega=55^\circ/s$ .

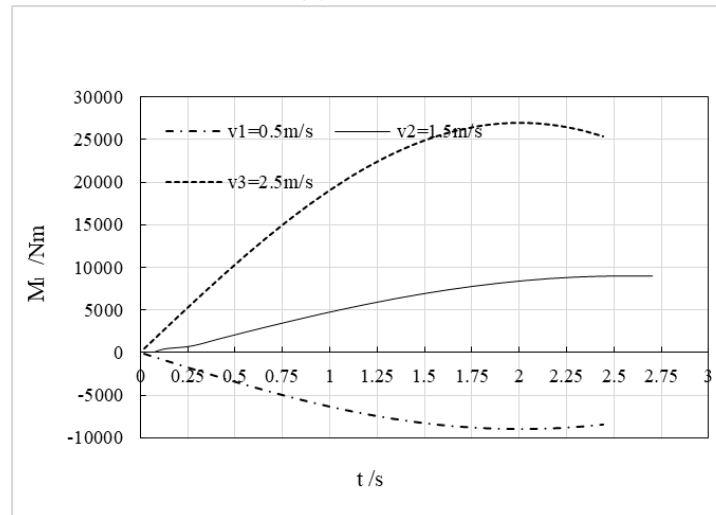

(c)  $\omega=65^\circ/s$ .

**Figure 4:** The torque with time and speed  $v$  under angular speed  $\omega$  and acceleration  $\omega'$  of  $55^\circ/s^2$ .

### Discussions

It is suggested that the big arm torque from Figure 3 happens when terminal speed & rotary angle and angular acceleration is bigger and smaller respectively. So that the reasonable parameters are chosen to design and evaluate their properties is important. Not to choose big terminal speed and acceleration is key in order to increase the capability and property that may increase the whole cost as well. The biggest one arrives 27.5KNm ET. 2.7 tonm at speed 2.5m/s and angel  $90^\circ$  under  $\omega=65^\circ/s$  and  $\omega'=55^\circ/s^2$  meanwhile it is 17KNm ET. 1.7tonm at the same conditions as above under  $\omega=40^\circ/s$  and  $\omega'=65^\circ/s^2$ . Here 1KNm=0.1tonm. The biggest distance between neighbour speed  $v$  is 21.5KNm under  $\omega=65^\circ/s$  and  $\omega'=55^\circ/s^2$ , meantime the least torque between neighbour speed is 1KNm under  $\omega=35^\circ/s$  and  $\omega'=65^\circ/s^2$  (Figures 3,4).

It is suggested that the big arm torque from Figure 4 happens when terminal speed & rotary angle and angular acceleration is bigger and smaller respectively. So that the reasonable parameters are chosen to design and evaluate their properties is important. Not to choose big terminal speed and acceleration is key in order to increase the capability and property that may increase the whole cost as well. The biggest one arrives 27.5KNm at speed 2.5m/s and angel  $90^\circ$  under  $\omega=65^\circ/s$  and  $\omega'=55^\circ/s^2$  meanwhile it is 17KNm at the same conditions as above under  $\omega=40^\circ/s$  and  $\omega'=65^\circ/s^2$ . There is not big difference between above two angular acceleration with  $55^\circ/s^2$  and  $65^\circ/s^2$ . This expresses that the big difference causes big different torque in robotic arm1. Overview the computation solution is tedious to use in software like Excel and Origin since it has many small equations. The result is satisfactory and precise to be adopted to numerical simulation so the five freedoms method based on  $\omega'=55^\circ/s^2$ ,  $\omega'=65^\circ/s^2$  is



approaching. In Figures 3,4 with increasing terminal speed the torque may be increased and with angular speed becoming big the torque may be increased. The biggest torque is 27.5KNm and 21KNm when angular speed is 60~50°/s and angular acceleration is 30 °/s<sup>2</sup> respectively. This one needs to be checked the strength correction when the speed is 2.5m/s. The  $\omega$ 1~3 is supposed to be same with angular speed  $\omega$  and angular acceleration  $\omega'$  of 55°/s<sup>2</sup> and 65°/s<sup>2</sup> in Figure 3~4 in addition. The least torque is 15KNm and 17KNm when angular speed is 30~40°/s and angular acceleration is 65 °/s<sup>2</sup> respectively. So the effective turn to torque 1 is  $v > \omega > \omega'$ .

## Conclusions

There is big distance to attain 27.5KNm between the difference speeds of conditions  $v=0.5\sim 2.5\text{m/s}$  at angle speed  $\omega=65^\circ/\text{s}$  and acceleration  $\omega' = 55^\circ/\text{s}^2$ . When the  $\omega$  increases the torque will become big, meantime when the speed  $v$  increases the torque is big too. The biggest one is 17KNm with above condition at angular speed  $\omega=40^\circ/\text{s}$  and acceleration  $\omega' = 65^\circ/\text{s}^2$ . It means that the decreased acceleration will increase the torque. The least one is happened on  $\omega=35^\circ/\text{s}$ . there is little change between acceleration  $\omega' = 55^\circ/\text{s}^2$  and  $65^\circ/\text{s}^2$ . There is a trend the former is a little larger than the later. Therefore the effective turn to torque is  $v > \omega > \omega'$ .

## References

1. Zhang CE. Machinery dynamics. Higher Educational Press. 2008; 96.
2. Xu R, Hur B. The numerical simulation of force with parameters in three & five freedoms of robotic arm I. East African Scholars J Eng Comput Sci. 2021; 4: 69-73.
3. Xu R. The numerical simulation of forces with high angular speed and low angular acceleration in three and five freedoms of robotic arm I. SunText Review Material Sci. 2022; 3: 1154.
4. Xu R, Hur B. A Simulation between Torque and Angle with Speed on Five Freedoms of Robot Mechanical Arm in Multibody Systems. Saudi J Civil Engg. 2021; 5: 91-93.
5. Yan P. Base on dynamics analysis and precise design with mechanical arm of arthritis rub. Master Degree Thesis. Jiangsu University of Technology. 2012; 3: 18.
6. Li Z, Wu C. The Dynamics solving method of flexible joint robot based on quantized state system. J Mechanical Engg. 2020; 56: 122.